

# The Whole House Water Filter

**FILTER-500L**

**FILTER-600L**

**FILTER-1200L**

**FILTER-1500L**

**FILTER-1800L**

## User Manual

Please read this manual in details before using the device and keep it properly in order to consult in the future.

Note: The design and specifications are subject to the changes without prior notice. We reserve the right of interpretation to the user manual.

0WRX.466.571

# Catalogue

Preface.....	
1.Product Profile.....	
2.Working Principle.....	
3. Assembly & Parts.....	
4.Specification & Active Carbon Volume.....	
5. Application Range.....	
6. Technical Parameters.....	
6.1 Parameter Table.....	
6.2 Working Condition.....	
7. Function and Characteristics.....	
8.Installation.....	
8.1Installation Condition.....	
8.2Installation and Connection.....	
8.3Control Valve Set and Usage.....	
※ The Function of Control Panel and Parameter Setting.....	
※ Parameter Set.....	
※ Flow Chart.....	
9.Usage Illustration.....	
10.Notice.....	
11.Troubles-Shooting.....	
12.Maintenance.....	
13.Warranty Guidance.....	

# Preface

Thanks for choosing our products. The whole house water filter series products are featured by reduction of residual chlorine and other impurity things. It can meet the demand of daily laundry, bath, cleaning and provide drinking water with high quality for organization, school, group, etc.

In order to correctly install, set, use and maintain products, please do read the manual in details and strictly follow the steps to install and use the products. You can refer to this manual to solve problems that you meet during the usage. This manual and product warranty card should be kept properly.

## 1.Product Profile

The product is working automatically and intelligently. It adopts food-grade active carbon to filter the raw water with the characteristics of high flow rate, good filtering effect, automatic rinsing and long life time. It removes the harmful things efficiently such as residual chlorine, abnormal smell, rust, mud, etc. After the active carbon disabled, the device could rinse automatically to regenerate the carbon to make it recovering the function of filtering. The device has the functions of service, backwash and fast rinse which are full automatically realized.

It adopts LCD display screen, menu control and hommization icons, featured by concision and intuition. Users can set parameters and conduct operations according to the menu icons that display on the screen.

## 2.Working Principle

The active carbon has the adsorption character and large surface which could absorb the impurity things from water, such as abnormal smell, residual chlorine to make the drinking water taste better. According to the pre-set program, it can automatically control the open and close of each valve, so as to realize of filtering, backwash and fast rinse.

### 3. Assembly & Parts

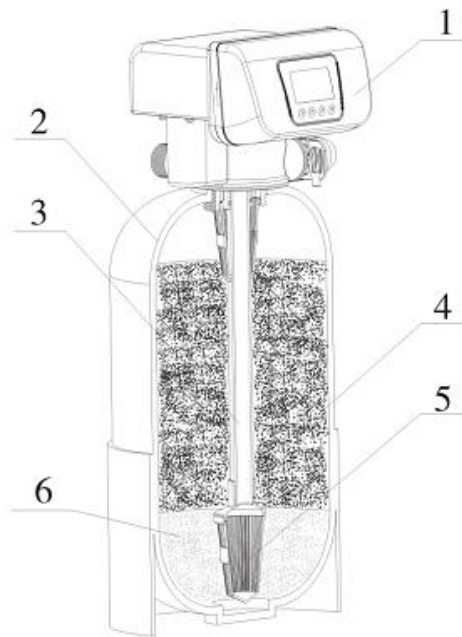

No.	Description	No.	Description
1	Automatic Multi-port Valve	4	Active Carbon
2	FRP Tank	5	Strainer
3	Riser Pipe	6	Quartz Sand

### 4. Specification and & Active Carbon Volume

Model	FRP Tank Size (Φ*h)mm	FRP Tank Model	Active Carbon Volume L	Quartz Sand Volume L
FILTER-500L	258*330	1013	5	4
FILTER-600L	258*434	1017	7	4
FILTER-1200L	258*897	1035	22	4
FILTER-1500L	258*1121	1044	31	4
FILTER-1800L	258*1381	1054	38	4

## 5. Application Range

Tap water or other water source which meet the requirement for whole house water filter.

## 6. Technical Parameters

### 6.1 Parameter Table

Model	Rated Service Flow Rate of Products Approval Related to Drinking Water L/h	Water Treatment Capacity m <sup>3</sup>	Working Pressure MPa
FILTER-500L	500	1.1	0.15-0.4
FILTER-600L	600	1.5	
FILTER-1200L	1200	3.5	
FILTER-1500L	1500	5	
FILTER-1800L	1800	6	

### 6.2 Working Condition

Working Condition	Working Pressure	0.15MPa~0.4MPa
	Water Temperature	5℃~38℃
Working Environment	Environment Temperature	4℃~40℃
	Relative Humidity	≤95% (25℃)
	Electrical Facility	AC100~240V/50~60Hz
Water Quality	Turbidity	<20FTU
Inlet/Outlet	G1 or G3/4	
Drain	G1 or G3/4	

## 7. Function and Characteristics

1. Active carbon has a good performance on adsorption.

- Deodorization: Remove the abnormal smell which is caused by phenol or oil.
- Discoloration: Remove the color which is caused by the pollution of organic or resultant

generated by iron, manganese or plant.

- Dechloridation: Remove the stink which is caused by disinfectant in drinking water (Residual chlorine).

- Remove TOC: Remove 10-60% of organic pesticide, insecticide, chlorinated hydrocarbon, etc.

- Remove heavy metal: Such as Hg, Cr, etc.

- Remove synthetic detergent and dyestuff.

- Remove virus.

- Remove radioactive substances.

- Remove mutagenic substances in water.

2. Regeneration starts automatically: According to the regeneration time and water treatment capacity of one cycle, the system will start the regeneration program.

3. Automatic memory function: The parameters set by users, such as rinsing time, backwash time, fast rinse time and so on, can be saved for good no matter how long the power is off.

4. Language can be chosen: Chinese or English can be chosen so as to meet the habit of users.

5. Buttons lock function: No operations to buttons on the controller within 1 minute, buttons are locked. Press and hold the “▲” and “●” buttons for 5 seconds to unlock. This function can avoid incorrect operation.

## 8. Installation

### 8.1 Installation Condition

※Place the product on the flat surface that can bear the weight more than 3 times of the machine. Besides, there are water inlet and water outlet, drain pipeline and sewage in the workplace. For the automatic product, it also needs the AC power receptacle.

※Generally, the products are installed in the equipment room, underground garage (These places should have water inlet pipeline, water outlet pipeline, drain pipeline and sewage). Or they can be connected with the main water inlet of the place, such as villas, apartments, schools or business establishments, etc. If it is necessary, you can install the product outdoor. However, you should take some protective measures to prevent the product from being frostbiting, basking and water.

※Do not put the product near the place with alkaline and acid substance or gas, avoiding being corroded.

※The suitable pressure for filter is between 0.15Mpa and 0.6Mpa. Booster pump or a relief valve is necessary when the inlet pressure is lower or higher than standard.

※Make sure a check valve is equipped between the device and water heater when a heating stove or water heater is connected behind the device, in case of hot water reflux and damage the inner system of the product.

※Separate sewer line for the device is required. 5 to 10cm clearance must be maintained between the drain pipe and floor drain, in case of siphon and cause valve damage by the waste water.(Installation refer to below picture)

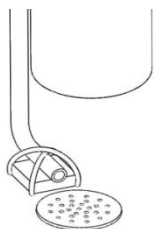

※Before installing the pipeline, please clean the residual impurity and dust in the pipeline. After the main water inlet is closed, connect it with the device.

※All of pipeline that used should meet the relevant regulations, and the installation should accord with the local installation rules.

※When install, please keep a certain operation space for adding salt, cleaning and maintaining.

### 8.2 Installation and Connection

※ Pipeline installation and connection should conform to the local installation rules. Inlet/outlet should be connected with the water pipe in the same axis (Refer to the below installation picture). The position of inlet and outlet shouldn't be reversed.

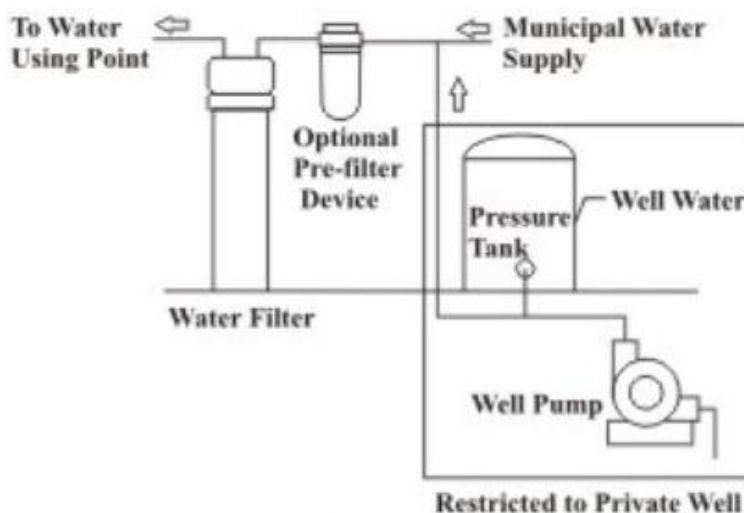
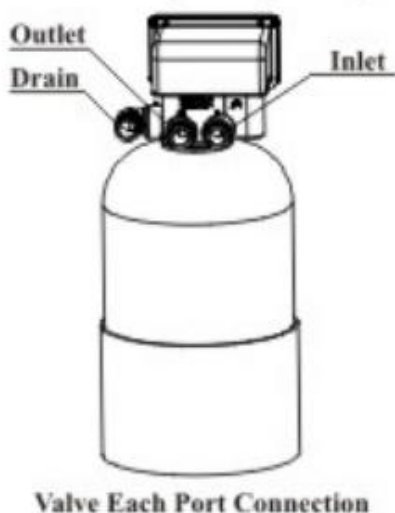

※It is suggested to install a manual bypass valve between the main water inlet and inlet/outlet of the device, making it convenient for installation and maintenance. (Refer to the below installation picture).

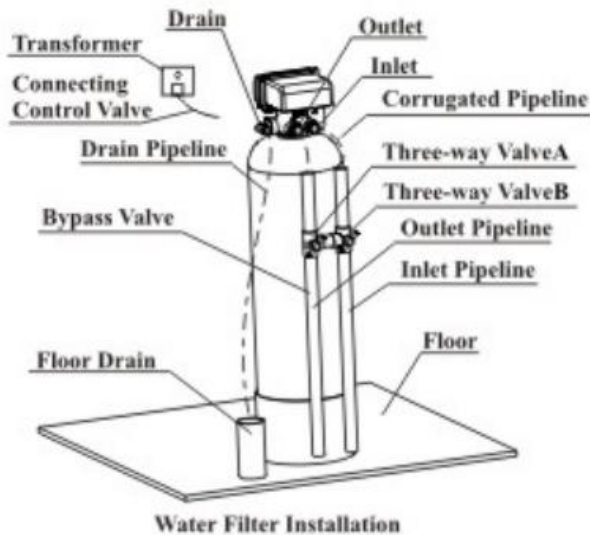
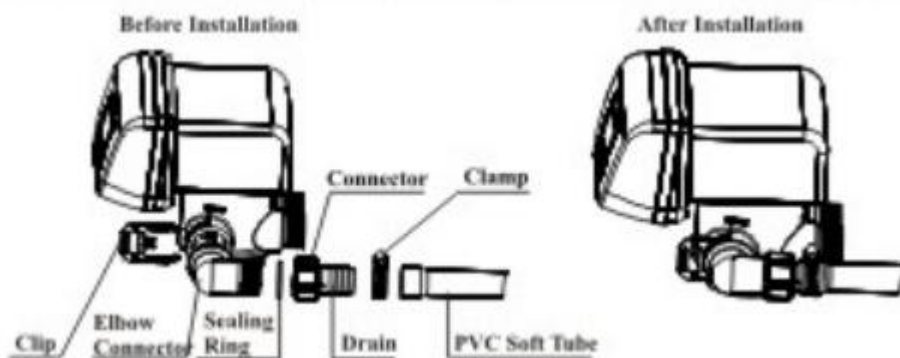

Illustration: Install two three-way ball valves to connect the control valve and inlet/outlet pipeline. The valve B is connected with the inlet of the control valve; the valve A is connected with the outlet of the control valve. When repair the tank, adjust the valve A and B to make the inlet connected with outlet directly, so the water do not pass through the valve; When normally use, adjust the vale A and B connected with valve.

※Install the drain pipeline of water filter, use the PVC soft or hard tube.

#### 1. Use PVC soft tube for installation

Take out the soft tube and metal clamp from the spare part kit, make the drain connector insert into soft tube as much as possible, the insert part is no less than 20 mm (In winter, the temperature is low, use the hot water to make the head of tube soft which is convenient for installation.) After insert, put metal clamp on tube and tighten it by screwdriver. If it is not convenient to assemble the tube on filter, it could remove the drain connector then assemble the tube. Take out the clip before removing the drain connector (See following picture).



#### 2. Use PVC hard tube for installation

When use PVC hard tube for installation, remove the connector and sealing ring as the following picture. It needs professionals to install. The installation is like the following picture.

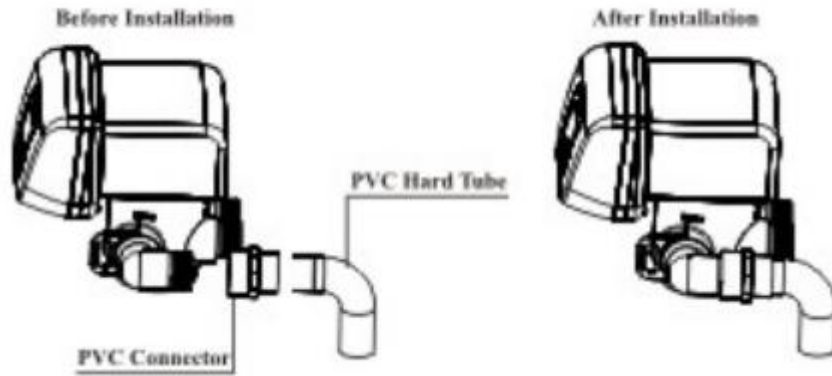

※Control valve should be higher than sewer. The length of drain line should be similar to the height of tank. Insert the drain line to the floor drain, but not to the bottom. Leave about 5-10mm distance between the end port of drain line and sewer.

※Each pipeline should be supported with fixed holder independently, avoiding the control valve be damaged by bearing the gravity from the pipeline.

**Notice: Please make sure the drain line and overflow line is connected and close to sewer, making the waste water flow into the sewer rapidly.**

### 8.3 Control Valve Set and Usage





※The Function of Control Panel and Parameter Setting

For this series products, foreground mode and background mode can be selected. Foreground mode is suitable for user and can set Time of Day, Rinsing Time, etc. Background mode can set other parameters by manufacturer, such as Service, Backwash Time, Fast Rinse Time, etc.







Foreground parameter enquiry and setting







A.  Button lock indicator

-  Lights on, indicating the buttons are locked. At this moment, press any single button will not work (No operation in one minute,  will light on and lock the buttons.)
- Solution: Press and hold both  and  for 5 seconds until the  lights off.







B. “” Menu/Confirm button

- Press  under the service status, the system turns into setting interface. Select the item and inquire the value.
- Under inquiry status, press  and the digits flash. It turn into setting interface, and you can adjust the parameters by press  and .
- After the setting, press  and turn into setting interface by saving the settings with a “Di” sound.

C. “” Manual/Return button



- Press  under the service status, the system will finish current status and turn into next status immediately. (For example: If the quality of outlet water fails, after unlocking the buttons, press  in service status, it will start regeneration cycles instantly; During the cycle of regeneration, if you want finish current steps in advance, press  and it will turn into next step at once.)
- Press  under the inquiry status, the system will turn back to service status interface; Press  under the setting status, the system will turn back to inquiry status.
- Under the setting status, press  and the system will turn back to inquiry status without saving the setting value.

D. Down  and Up 

- Under the inquiry status, press  or  to view all values.
- Under the setting status, press  or  to adjust values.
- Press and hold both  and  for 5 seconds to lift the button lock status.

※Parameter Setting (By users)

Item	Parameter Set Arrange	Factory Default
Time of Day	00:00~23:59	Current time
Rinsing Time	00:00~23:59	02:00

- Press and hold both  and  for 5 seconds under the service status, till the  lights off.

## Process Display

### ① User Mode

After power on, the following interface will show 3 seconds, and then enter into user mode.



### ② F67D process display

12:30:25 System in Service	02:08:00 In Backwashing... Remaining: 3 min.	02:17:25 In Fast Rinse... Remaining: 3 min.	Motor Running...
-------------------------------	--	---	------------------

Service Status

Backwash Status

Fast Rinse Status











Motor Operation

Illustration:

Working process of F67D/F71D: Service→ Backwash→ Fast Rinse→ Service (So circulate).



### F67D Residential Filter valve setting items and process

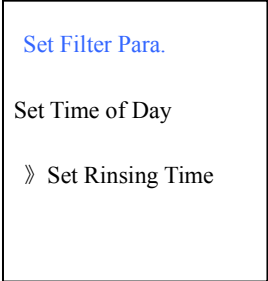

Items	Process steps	Symbol
Time Of Day	<p>When  lights on, press and hold both  and  for 5 second until  lights off.</p> <p>1. Press  and enter into the interface of "Set Filter Para.", as the figure J1 shows. The item of "Set Time of Day" will be selected by system automatically.</p> <p>2. Then press , and the setting interface will display as the figure J2; The hour value "12" flashes, through  or  to adjust the hour value.</p> <p>3. Then press  again, the minute value "30" flashes, through  or  to adjust the minute</p>	<div style="border: 1px solid black; padding: 10px; margin-bottom: 10px;"> <p style="color: blue;">Set Filter Para.</p> <p style="padding-left: 20px;">» Set Time of Day</p> <p style="padding-left: 20px;">» Set Rinsing Time</p> </div> <p style="text-align: center;">J1</p> <div style="border: 1px solid black; padding: 10px; margin-bottom: 10px;"> <p style="color: blue;">Set Time of Day</p> <p style="padding-left: 20px;">12: 30</p> </div> <p style="text-align: center;">J2</p>

	<p>value.</p> <p>4. Lastly, press  and hear a sound “Di”, then finish adjustment.</p>	
Rinsing Time	<p>1. Press  and enter into the interface of “Filter Filter Para.” ,as the figure J1 shows.</p> <p>2. Press  and select the item of “ Set Rinsing Time”; Then press , the setting interface will show as the figure J3; The hour value 02 flashes, through  or  to adjust the hour value.</p> <p>3. Then press , the minute value “00” flashes, through  or  to adjust the minute value.</p> <p>4. Lastly, press  and hear a sound “Di”, then finish adjustment.</p>	 <p style="text-align: center;">J3</p>

※Background parameter inquiry and setting (Operated by manufacturer or professional dealer)

#### A. Enter background mode

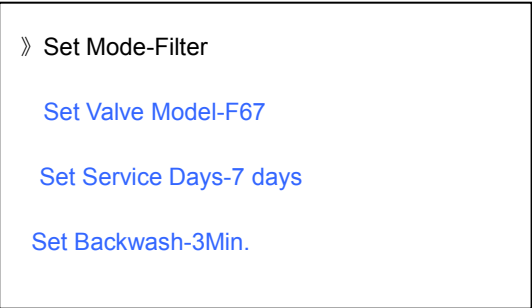

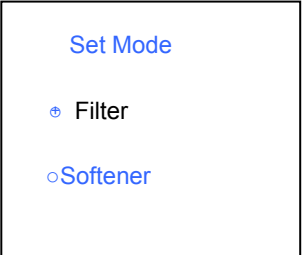
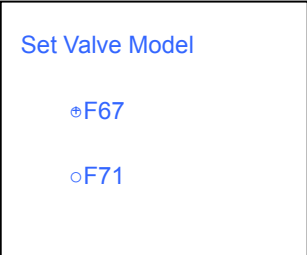
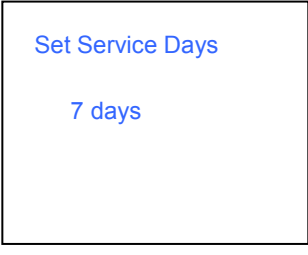
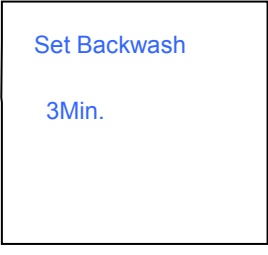

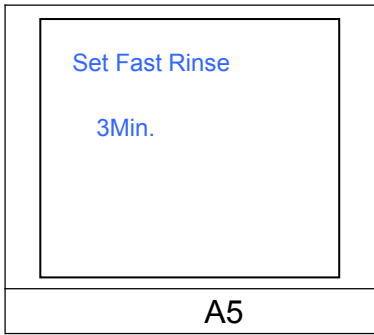
Within 6 seconds of the L1 displaying, press and hold  and  for more than 3 seconds to enter the background setting menu. The interface as the H1 shows (Including H1-1 and H1-2)





			
H1-1		H1-2	
			
A1	A2	A3	A4













B. Parameter set in background

Parameters could be set in background: Set Mode, Set Valve Model, Set Service Days, Set Backwash, Set Fast Rinse(For water filter setting)

a) In the H1 interface, select the “Mode” and press , as the figure A1 shows. Press  or  to select the mode that you need. Select Filter for water filter. After that, Press  to save the setting and turn back to H1; or press  to turn back to H1 without saving the setting.

b) In the H1 interface, select “Set Valve Model” and press , as the figure A2 shows. Press  or  to select the matched valve type. Press  to save the setting and turn back to H1; or press  to turn back to H1 without saving the setting.

c) In the H1 interface, select “Set Service Days” and press , as the figure A3 shows. Press  or  to select the days that you need. Press  to save the setting and turn back to H1; or press  to turn back to H1 without saving the setting.

d) In the H2 interface, select “Set Backwash” and press , as the figure A4 shows. Press  or  to select the backwash time that you need. Press “” to save the setting and turn back to H1; or press “” to turn back to H1 without saving the setting.





e) In the H2 interface, select “Set Fast Rinse” and press , as the figure A5 shows. Press  or  to select the fast rinse time that you need. Press  to save the setting and turn back to H1; or press  to turn back to H1 without saving the setting.

Illustration: For this series products, you don't need set the background parameters. All of them are already set by manufacturer according to the product type and specification. If you have to reset, please makes sure the work is done by professional.

※Parameter Set (Only for factory or professional dealer)

Model	Backwash Time (Minute)	Fast Rinse Time (Minute)	Regeneration Days (Day)
RL-J50	2	2	5
RL-J60			

RL-J120	3	3	7
RL-J150			
RL-J180	4	3	10

※Flow Chart

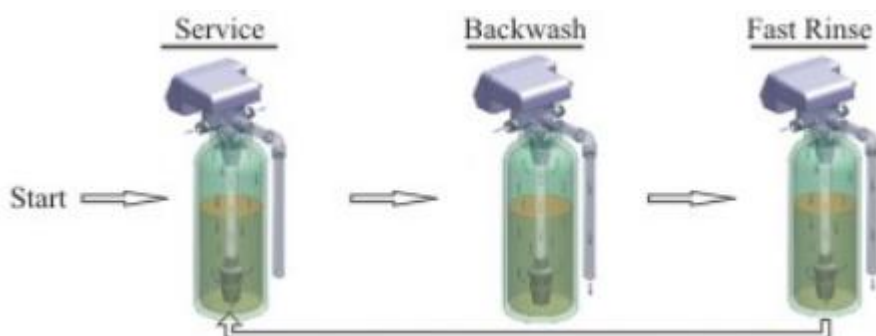

## 9. Usage Illustration

After installing the device and setting the relevant parameters, please conduct the trial running as follows:

Switch on power. Press  and go in the Backwash status; adjust the bypass valve (Three-way valve A and B) to service position, slowly open the inlet valve. At this moment, the air is emptying from the drain pipeline. Until the drain water is clean.

Press , and turn into Fast Rinse status. Until the drain water is clean.

It needs couple times of backwash and fast rinse for the first time usage.

Press  to back to Service status, open the faucet to check if the water is clean. If the water is still carbon color, it needs more backwash and fast rinse.

Illustration: The purpose of frequently backwash and fast rinse for the first time of using the system is to clean the carbon powder and activate it which is food grade. So there may be some black water flowing out.

### Notice:

**If the water is entering fast, the media in tank will be loss. When water is entering slowly, you can hear the sound of air-out from the drain pipeline**

**During the trial running, check each port, there should be no media flowing out. Check each connection part, be sure there is no leakage.**

**The time of backwash and fast rinse is set depending on the practical need.**

## 10. Notice

Before reading and understanding the manual instruction, please do not operate the device.

10.1 Forbid installing the device near heat source or take anti-heat protective measures when install near the heat source. It is also forbidden to connect the device with the hot-water pipeline or the pipeline with the possibility of hot-water returning.

10.2 If the raw water fails to meet the standards of local tap water, such as big content of sand, the pretreatment device should be installed before the device.

10.3 Without being used for a long time or the pressure of the inlet water is instable, please close the inlet port and turn off the power. Before using again, please firstly conduct a regeneration cycle through manual operation so as to ensure the quality of filtering water.

10.4 When use the filter for the first time or the device is idle for long period, it is normal that the outlet water is black. It needs couples times of backwash and fast rinse.

10.5 If the water demand is increasing (Compared to usual demand) or the raw water quality is reducing, please add the backwash and fast rinse times.

10.6 As the product is constantly updating, the possibility that the manual instruction can't accord with the product may happen. So, it is subjected to the actual product.

**Special note: The tap pipeline pressure is unstable (General speaking, the pressure at night is higher than the daytime), so at the beginning two days after the system installed, pay close attention to each connection port if there is any leakage.**

## 11. Troubles-Shooting

Trouble details	Cause	Solution
1.Filter doesn't rinse.	A. Power outage. B. Incorrect rinsing time set. C. Controller broken.	A. Check the power (Check fuse, plug, pull chain or switch). B. Reset rinsing time. C. Check or replace the controller.
2.Not good quality of filtered water.	A. Bypass valve opened. B. Leakage on riser pipe. C. Valve body internal leakage. D. Active carbon invalid. E. Short time of rinsing.	A. Close the bypass valve. B. Ensure the riser pipe and o ring are good. C. Repair or replace the valve body. D. Replace the active carbon.

		E. Adjust the rinsing time.
3. Regeneration too often or less.	A. Regeneration cycle set incorrect.	A. Set the correct the regeneration cycle depending on the raw water quality and usage of end-user.
4. Loss of media through drain line.	A. Air in water system. B. Big flow rate of backwash. C. Bottom strainer broken.	A. Assure that well system has proper air eliminator control. B. Reduce the backwash flow rate. C. Replace new bottom strainer.
5. Control cycle continuously.	A. Locating signal wiring breakdown. B. Controller is faulty. C. Foreign material stuck the driving gear.	A. Check and connect locating signal wiring. B. Replace controller. C. Take out foreign material.
6. Drain port continually drain.	A. Valve body internal leakage. B. Power off when valve in backwash or fast rinse.	A. Repair or replace the valve body. B. Close the bypass valve until the power is on.
7. All indicators display on display board.	A. Wiring of display board with control board fails to work. B. Main control board is faulty. C. Adapter is damaged. D. Voltage is unsteady.	A. Check and replace it. B. Replace main control board. C. Check and replace adapter. D. Check the voltage and adjust it.
8. No display on display board.	A. Wiring of display board with control board fails to work. B. Display board is damaged. C. Main control board is damaged. D. Electricity is interrupted.	A. Check and replace it. B. Replace display board. C. Replace main control board. D. Check electricity.
9. E1 Flashes	A. Wiring of locating board with control board is damaged. B. Locating board is damaged. C. Mechanical driven is damaged. D. Control board is damaged. E. Wiring of motor with control board is damaged. F. Motor is damaged.	A. Replace wiring. B. Replace locating board. C. Check and repair mechanical part. D. Replace control board. E. Replace wiring. F. Replace motor.

10. E2 Flashes	<p>A. Hall component on locating board is damaged.</p> <p>B. Wiring of locating board with control board is damaged.</p> <p>C. Control board is damaged.</p>	<p>A. Replace locating board.</p> <p>B. Replace wiring.</p> <p>C. Replace control board.</p>
11. E3 or E4 Flashes	<p>A. Control board is damaged.</p>	<p>A. Replace control board.</p>

## 12. Maintenance

12.1 Before check-up please turn off the inlet of water filter.

12.2 Prohibit the use of harmful health detergents or chemicals to clean, wipe the device.

12.3 Wipe with a moistened soft fabrics to clean equipment surface dust and foreign matter, avoid the water into the valve internal erosion electrical components causing damage.

Note:

1. Check or replace the active carbon, the length of riser tube should be neither higher nor 10mm lower than the tank top opening height, and its top end should be rounded to avoid damage of O-ring inside the valve.
2. Avoid floccules substance together with resin to fill in the mineral tank.
3. Avoid O-ring inside control valve falling out while rotating it on the tank.

## 13. Warranty Guidance

Dear Customers:

Thanks for use water filter. For the protection of your rights, please read the manual and warranty guidance in details before using our products, so that we can service you better.

※ “Three Guarantees” period is one year since the purchase date (Refer to the date of guarantee card or other provable documents)

※ During the guarantee period, maintenance is free if the damage is caused by the product quality problems. However, if the damage is caused by user, we will charge you a certain fee.

※When guarantee period is expired, we will still provide after-sales service, such as maintenance, changing media, supplying parts, etc. The fee of materials and service will be charged according to our latest charging standards.

※It couldn't be repaired free of charge under the below conditions:

①Media, seal, decoration shell, the coating of appearance, etc.

②The damage is caused by force majeure, such as fire, flood, electric shock, earthquake, etc.

③The damage is result from the disassembly or refits by user or repair by non-scheduled maintenance unit.

④The damage is caused by the improperly transportation, installation, usage and maintenance.

⑤Content in guarantee proof is unconfirmed with the label on the real good or be altered.

⑥User can't provide the guarantee card or other proofs.

The product dealers are responsible for the maintenance and other after-sales service. (The guarantee card or other proof is effective with the dealers' stamp or our company's stamp)

Please keep the guarantee card properly and provide it when maintenance.